



Zeppelinstrasse 19

D-82205 Gilching

Fon +49-8105-778090

info@lcd-module.de

<http://www.lcd-module.com>

SPECIFICATION

CUSTOMER : _____

MODULE NO.: **EA TFT057-32ATS**

APPROVED BY: (FOR CUSTOMER USE ONLY)	PCB VERSION:	DATA:
--	---------------------	--------------

SALES BY	APPROVED BY	CHECKED BY	PREPARED BY
ISSUED DATE: 2022/03/01			

Content

- 1.Summary
- 2.General Specification
- 3.Absolute Maximum Ratings
- 4.Electrical Characteristics
- 5.DC Characteristics
- 6.AC Characteristics
- 7.Optical Characteristics
- 8.Interface
- 9.Block Diagram
- 10.Reliability
- 11.Touch Panel Information
- 12.Contour Drawing

1. Summary

This technical specification applies to 5.7' color TFT-LCD panel. The 5.7' color TFT-LCD panel is designed for camcorder, digital camera application and other electronic products which require high quality flat panel displays. This module follows RoHS.

1.1. Accessories

ZIF connector for display, bottom contact
ZIF connector for display, top contact
ZIF connector for touch panel, top contact

EA WF050-40S
EA WF050-40ST
EA WF050-10T

2. General Specifications

Item	Dimension	Unit
Size	5.7	inch
Dot Matrix	320 x RGBx240(TFT)	dots
Module dimension	141.12(W) x 101.55(H) x 8.235 (D)(MAX)	mm
Active area	115.2 x 86.40	mm
Dot pitch	0.12 x 0.36	mm
LCD type	TFT, Normally White, Transmissive	
View Direction	12 o'clock	
Gray Scale Inversion Direction	6 o'clock	
Backlight Type	LED, Normally White	
With /Without TP	With CTP	
Surface	Glare	

*Color tone slight changed by temperature and driving voltage.

3. Absolute Maximum Ratings

Item	Symbol	Min	Typ	Max	Unit
Operating Temperature	TOP	-20	—	+70	°C
Storage Temperature	TST	-30	—	+80	°C

Note: Device is subject to be damaged permanently if stresses beyond those absolute maximum ratings listed above

- Temp. $\leq 60^{\circ}\text{C}$, 90% RH MAX. Temp. $> 60^{\circ}\text{C}$, Absolute humidity shall be less than 90% RH at 60°C

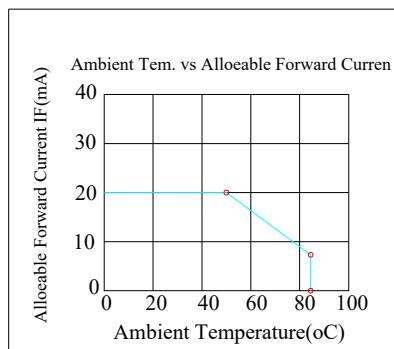

4. Electrical Characteristics

4.1. Operating conditions:

Item	Symbol	Condition	Min	Typ	Max	Unit
Supply Voltage For Logic	VCC	—	3.0	3.3	3.6	V
Supply Voltage For Touch Logic	VDDT	—	2.8		3.3	V
Supply Current	Icc	VCC=3.3V	—	140	210	mA

4.2. LED driving conditions

Parameter	Symbol	Min.	Typ.	Max.	Unit	Remark
LED current		-	140	-	mA	
Power Consumption		1260		1470	mW	
LED voltage	VBL+	9.0		10.5	V	Note 1
LED Life Time			50,000		Hr	Note 2,3,4

Note 1 : There are 1 Groups LED

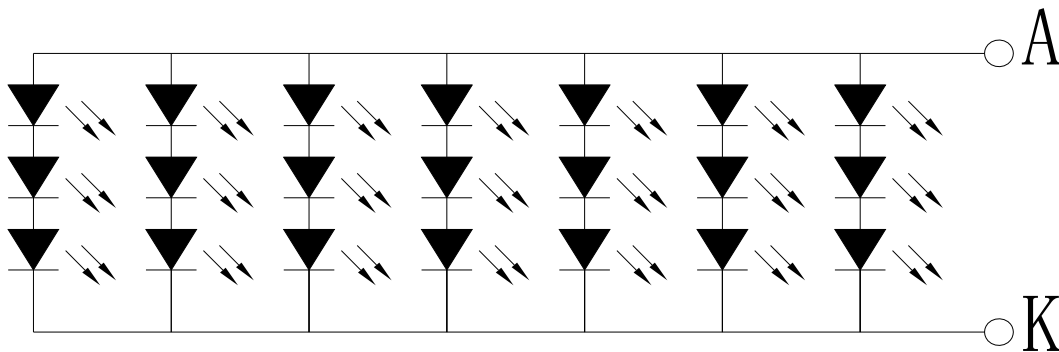

Note 2 : Ta = 25 °C

Note 3 : Brightness to be decreased to 50% of the initial value

Note 4 : The single LED lamp case.

5.DC CHARATERISTICS

Parameter	Symbol	Rating			Unit	Condition
		Min	Typ	Max		
Low level input voltage	V_{IL}	0	-	0.3VCC	V	
High level input voltage	V_{IH}	0.7VCC	-	VCC	V	

6.AC CHARATERISTICS

6.1. 24-bits parallel RGB Interface

AC Timing Characteristics

Signal	Item	Symbol	Min.	Typ.	Max.	Unit	
Dclk	Frequency	Dclk	-	6.4	-	MHZ	
	High time	Tch	-	78	-	ns	
	Low time	Tcl	-	78	-	ns	
Data	Setup time	Tds	12	-	-	ns	
	Hold time	Tdh	12	-	-	ns	
Hsync	Period	TH	-	408	-	DCLK	
	Pulse Width	Thp	-	30	-	DCLK	
	Back-Porch	Thb	-	38	-	DCLK	
	Display Period	Thd	-	320	-	DCLK	
	Front-Porch	Thf	-	20	-	DCLK	
Vsync	Period	NTSC	TV	-	262.5	-	DCLK
		PAL		-	312.5	-	
	Pulse Width		Tvp	1	3	5	TH
	Back-Porch	NTSC	Tvb	-	15	-	TH
		PAL		-	23	-	
	Display Period		Tvd	-	240	-	TH
	Front-Porch	NTSC	Tvf	-	4.5	-	TH
		PAL		-	46.5	-	

AC Timing Diagrams

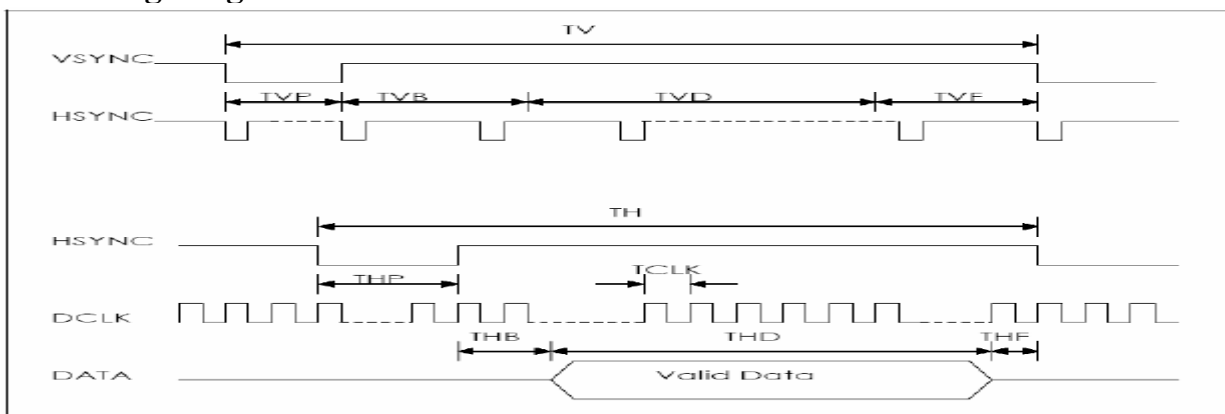

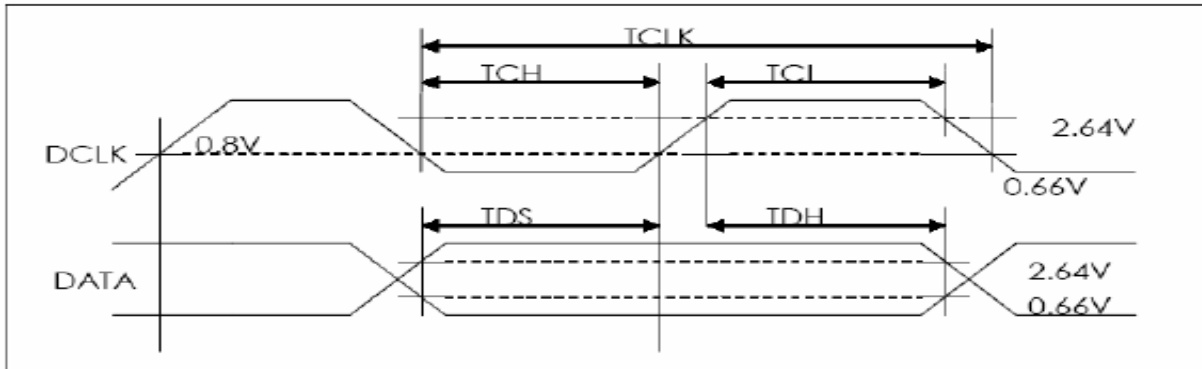

7. Optical Characteristics

Item	Symbol	Condition.	Min	Typ.	Max.	Unit	Remark
Response time	Tr	$\theta = 0^\circ$ 、 $\Phi = 0^\circ$	-	15	30	.ms	Note 3,5
	Tf		-	35	50	.ms	
Contrast ratio	CR	At optimized viewing angle	150	250	-	-	Note 4,5
Color Chromaticity	White	Wx	$\theta = 0^\circ$ 、 $\Phi = 0^\circ$	0.282	0.312	0.342	Note 2,6,7
		Wy		0.319	0.349	0.379	
Viewing angle (Gray Scale Inversion Direction)	Hor.	Θ_R	$CR \geq 10$	60	70	Deg.	Note 1
		Θ_L		60	70		
	Ver.	Φ_T		40	50		
		Φ_B		60	70		
Brightness	-	-	320	400	-	cd/ m ²	Center of display

Ta=25±2°C, IL=140mA

Note 1: Definition of viewing angle range

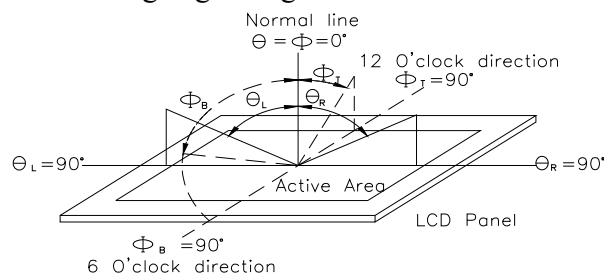

Fig.8.1. Definition of viewing angle

Note 2: Test equipment setup:

After stabilizing and leaving the panel alone at a driven temperature for 10 minutes, the measurement should be executed. Measurement should be executed in a stable, windless, and dark room. Optical specifications are measured by Topcon BM-7orBM-5 luminance meter 1.0° field of view at a distance of 50cm and normal direction.

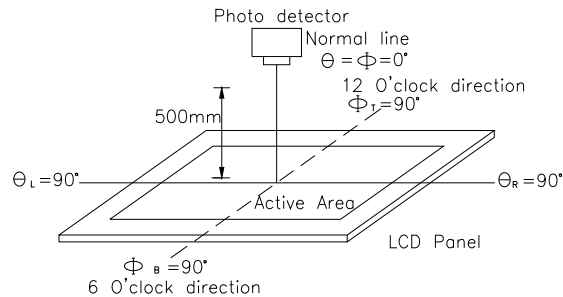
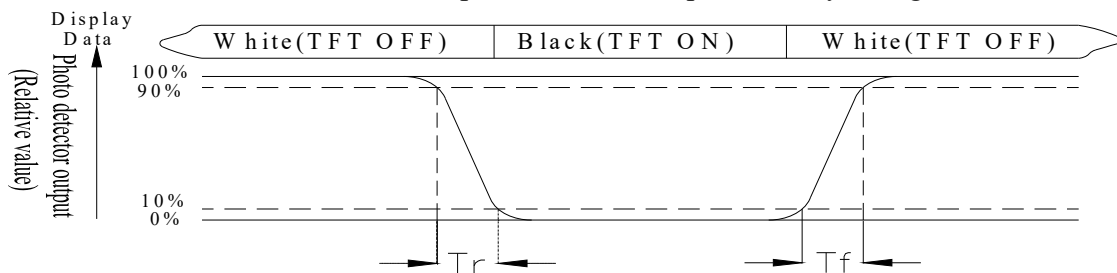

Fig. 8.2. Optical measurement system setup

Note 3: Definition of Response time:

The response time is defined as the LCD optical switching time interval between “White” state and “Black” state. Rise time, T_r , is the time between photo detector output intensity changed from 90% to 10%. And fall time, T_f , is the time between photo detector output intensity changed from 10% to 90%



Note 4: Definition of contrast ratio:

The contrast ratio is defined as the following expression.

$$\text{Contrast ratio (CR)} = \frac{\text{Luminance measured when LCD on the "White" state}}{\text{Luminance measured when LCD on the "Black" state}}$$

Note 5: White $V_i = V_{i50} \pm 1.5V$

Black $V_i = V_{i50} \pm 2.0V$

“±” means that the analog input signal swings in phase with VCOM signal.

“±” means that the analog input signal swings out of phase with VCOM signal.

The 100% transmission is defined as the transmission of LCD panel when all the input terminals of module are electrically opened.

Note 6: Definition of color chromaticity (CIE 1931)

Color coordinates measured at the center point of LCD

Note 7: Measured at the center area of the panel when all the input terminals of LCD panel are electrically opened.

8. Interface

8.1. LCM PIN Definition

Pin	Symbol	Function	Remark
1	NC	No connection	
2	NC	No connection	
3	GND	System ground pin of the IC.	Connect to system ground.
4	VCC	Power Supply	
5	R0	Red Data bit(LSB)	
6	R1	Red Data bit	
7	R2	Red Data bit	
8	R3	Red Data bit	
9	R4	Red Data bit	
10	R5	Red Data bit	
11	R6	Red Data bit	
12	R7	Red Data bit (MSB)	
13	G0	Green Data bit(LSB)	
14	G1	Green Data bit	
15	G2	Green Data bit	
16	G3	Green Data bit	
17	G4	Green Data bit	
18	G5	Green Data bit	
19	G6	Green Data bit	
20	G7	Green Data bit (MSB)	
21	B0	Blue Data bit(LSB)	
22	B1	Blue Data bit	
23	B2	Blue Data bit	
24	B3	Blue Data bit	
25	B4	Blue Data bit	
26	B5	Blue Data bit	
27	B6	Blue Data bit	
28	B7	Blue Data bit (MSB)	
29	GND	System ground pin of the IC.	Connect to system ground.
30	CLK	Dot data clock	
31	L/R	Shift direction of device internal shift register control.	Note2,3
32	Hsync	Horizontal sync signal	Note1
33	Vsync	Vertical sync signal	Note1
34	DE	Data Enable signal	Note1
35	U/D	Up/down selection	Note2,3
36	RESET	Hardware reset	
37	NC	No connection	
38	NC	No connection	
39	NC	No connection	
40	NC	No connection	

For digital 24Bit RGB input data format, both SYNC mode and DE mode are supported. If DE signal is fixed low, SYNC mode is used. Otherwise, DE mode is used. Suggest used SYNC mode!!

Mode	D[23:16]	D[15:8]	D[7:0]	IHS	IVS	DEN
24 bit RGB	R[7:0]	G[7:0]	B[7:0]	HSYNC	VSYNC	DE signal is fixed low for SYNC mode
				Floating if not used	Floating if not used	DE for DE Mode

Note 2: Selection of scanning mode

Setting of scan control input		Scanning direction
U/D	L/R	
GND	VCC	Up to down, left to right
VCC	GND	Down to up, right to left
GND	GND	Up to down, right to left
VCC	VCC	Down to up, left to right

Note 3: Definition of scanning direction. Refer to the figure as below:

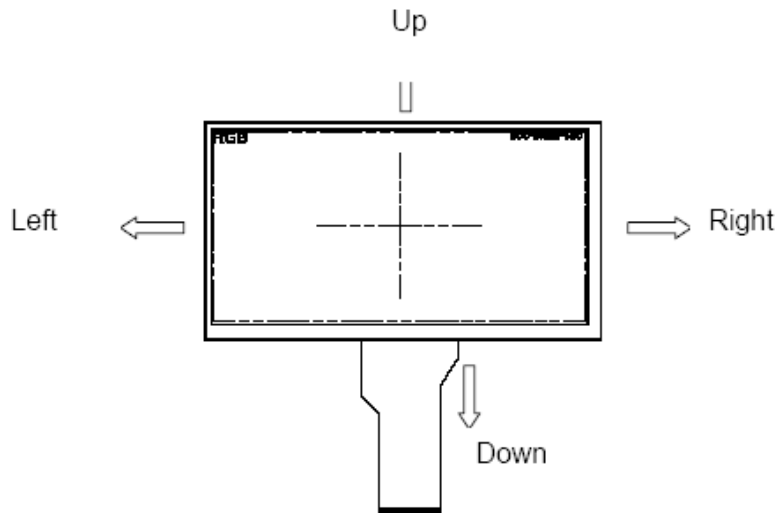

8.2. CTP PIN Definition

Pin	Symbol	Function	Remark
1	VSS	Ground for analog circuit	
2	VDDT	Power Supply : +3.3V	
3	SCL	I2C clock input	
4	NC	No connect	
5	SDA	I2C data input and output	
6	NC	No connect	
7	/RST	External Reset, Low is active	
8	/WAKE	External interrupt from the host	
9	/INT	External interrupt to the host	
10	VSS	Ground for analog circuit	

9. Block Diagram

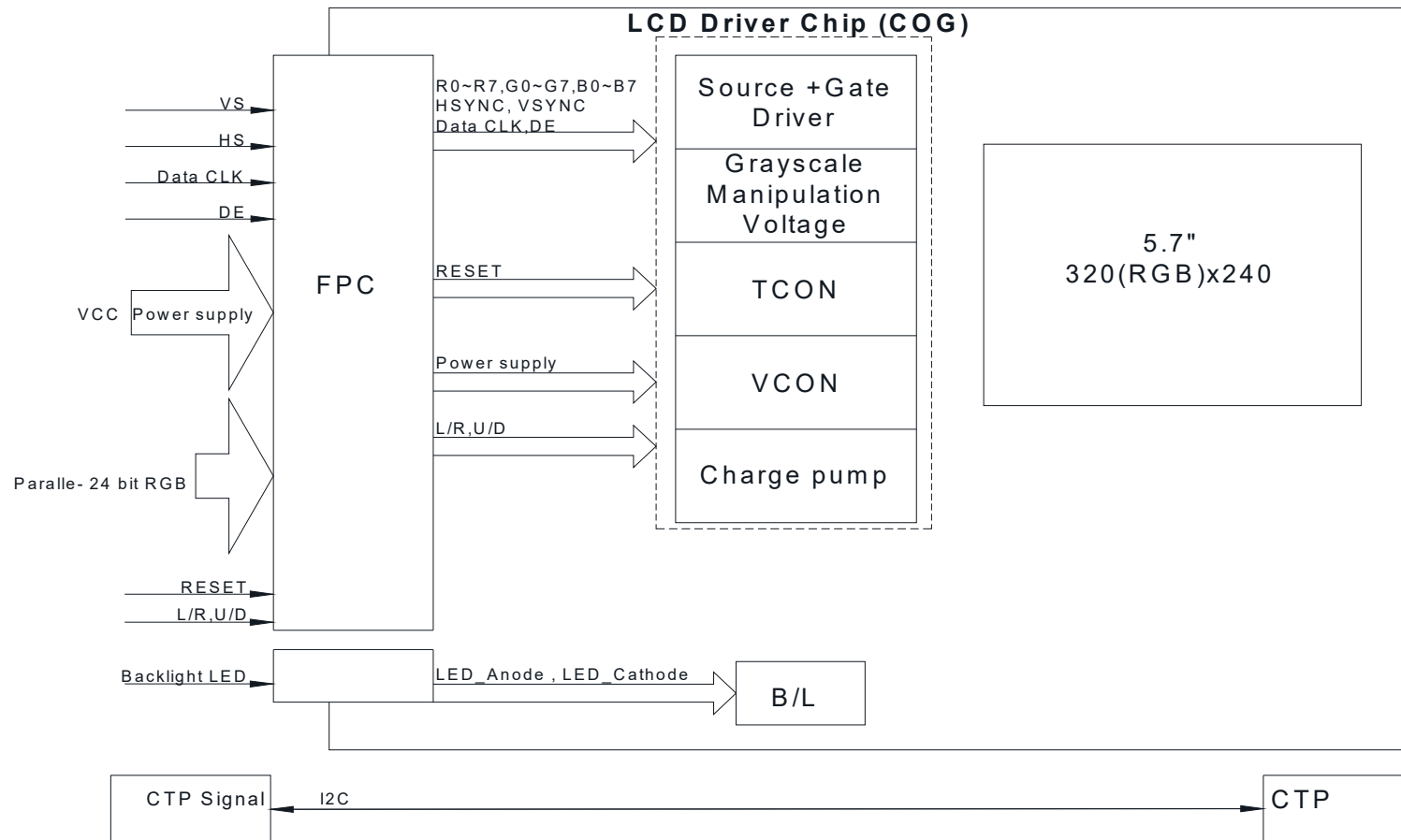

10. Reliability

Content of Reliability Test (Wide temperature, -20°C~70°C)

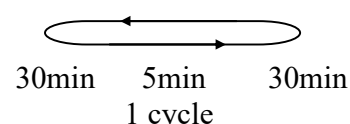
Environmental Test			
Test Item	Content of Test	Test Condition	Note
High Temperature storage	Endurance test applying the high storage temperature for a long time.	80°C 200hrs	2
Low Temperature storage	Endurance test applying the low storage temperature for a long time.	-30°C 200hrs	1,2
High Temperature Operation	Endurance test applying the electric stress (Voltage & Current) and the thermal stress to the element for a long time.	70°C 200hrs	—
Low Temperature Operation	Endurance test applying the electric stress under low temperature for a long time.	-20°C 200hrs	1
High Temperature/ Humidity Operation	The module should be allowed to stand at 60°C, 90%RH max	60°C, 90%RH 96hrs	1,2
Thermal shock resistance	The sample should be allowed stand the following 10 cycles of operation <div style="text-align: center;">  </div>	-20°C/70°C 10 cycles	—
Vibration test	Endurance test applying the vibration during transportation and using.	Total fixed amplitude : 15mm Vibration Frequency : 10~55Hz One cycle 60 seconds to 3 directions of X,Y,Z for Each 15 minutes	3
Static electricity test	Endurance test applying the electric stress to the terminal.	VS=±600V(contact), ±800v(air), RS=330 Ω CS=150pF 10 times	—

Note1: No dew condensation to be observed.

Note2: The function test shall be conducted after 4 hours storage at the normal Temperature and humidity after remove from the test chamber.

Note3: The packing have to including into the vibration testing.

11.Touch Panel Information

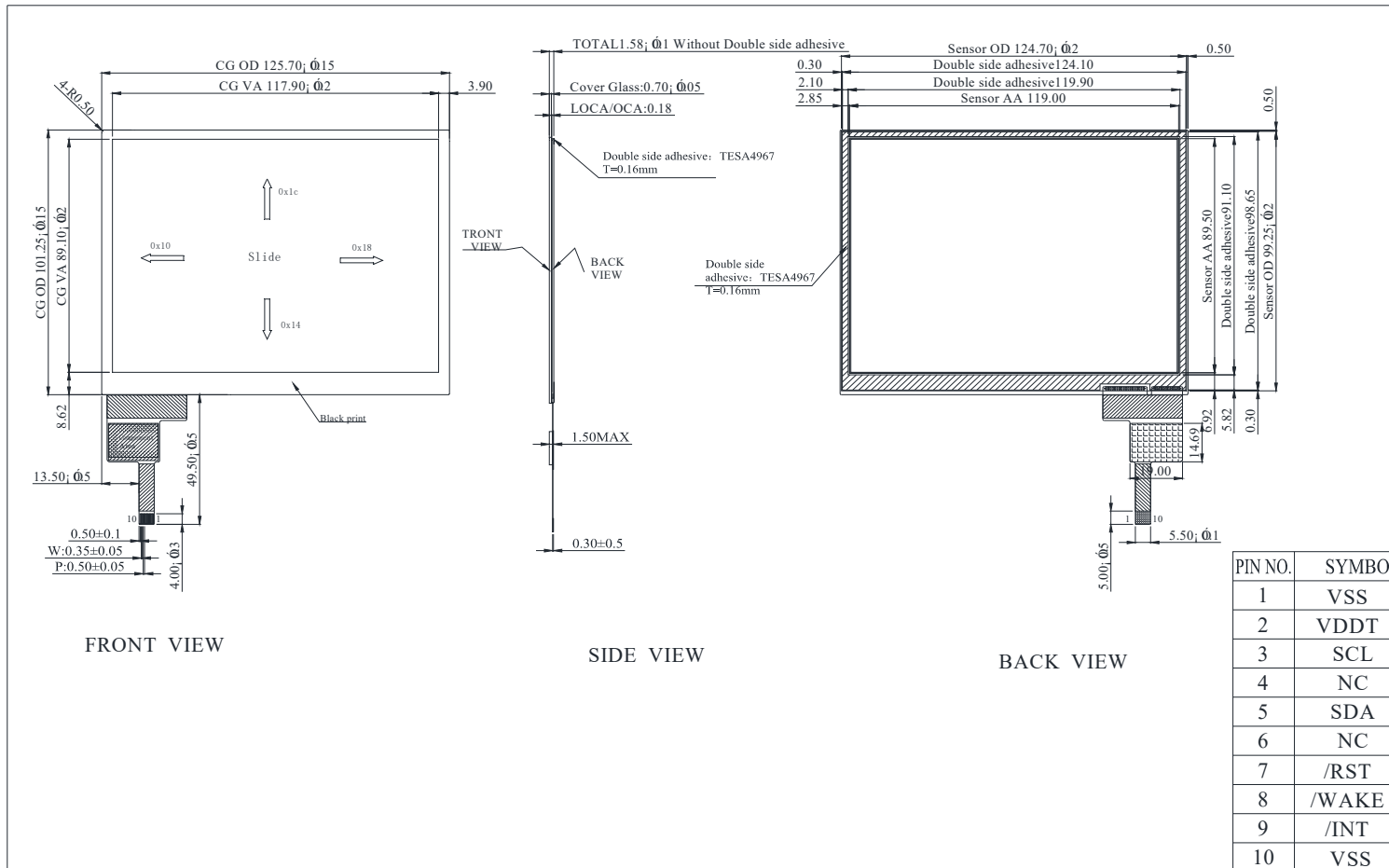

PIN NO.	SYMBOL
1	VSS
2	VDDT
3	SCL
4	NC
5	SDA
6	NC
7	/RST
8	/WAKE
9	/INT
10	VSS

11.1. CTP I2C Timing:

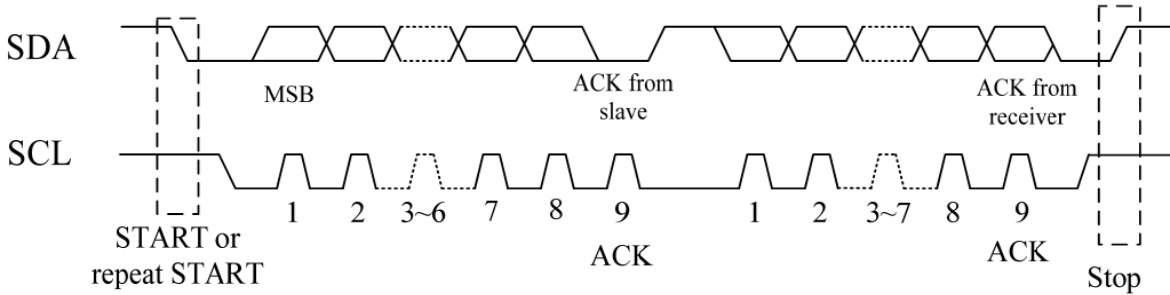

I2C Serial Data Transfer Format

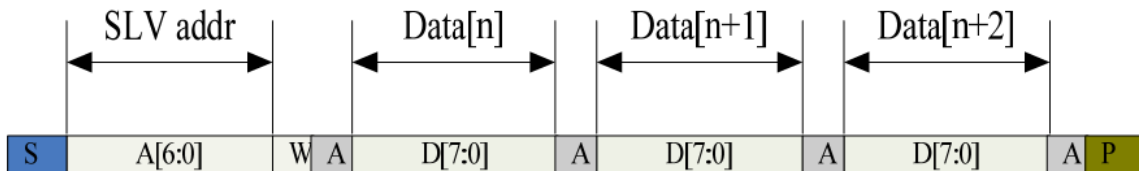

I2C master write, slave read

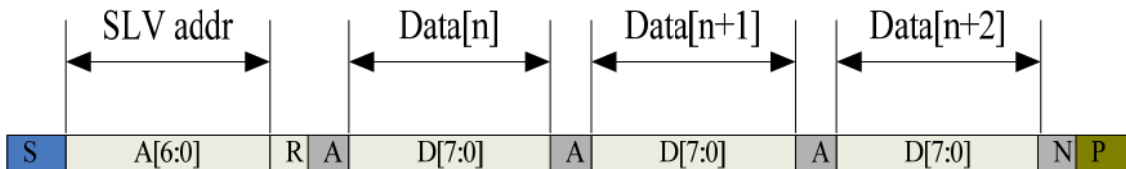

I2C master read, slave write

Mnemonics	Description
S	12C Start or 12C Restart
A[6:0]	Slave address A[6:4]:3'b011 A[3:0]:data bits are identical to those of 12CCON[7:4]register
W	1'b0:Write
R	1'b1:Read
A(N)	ACK(NACK)
P	STOP :the indication of the end of a packet(if this bit is missing, S will indicate the end of the current packet and beginning of the next packet)

Lists the meanings of the mnemonics used in the above figures

Parameter	Unit	Min	Max
SCL frequency	KHz	0	400
Bus free time between a STOP and START condition	us	4.7	\
Hold time (repeated) START condition	us	4.0	\
Data setup time	ns	250	\
Setup time for a repeated START condition	us	4.7	\
Setup time for STOP condition	us	4.0	\

Interface Timing Characteristics

AS FOR STANDARD CTM, HOST NEED TO USE BOTH INTERRUPT CONTROL SIGNAL AND SERIAL DATA INTERFACE TO GET THE TOUCH DATA.

HERE IS THE TIMING TO GET TOUCH DATA.

12.2. WRITE BYTES TO I2C SLAVE

The I²C address is set to 0x70 (0x38). Controller is FT5426DQ8 or compatible and resolution 1048x1024 dots.

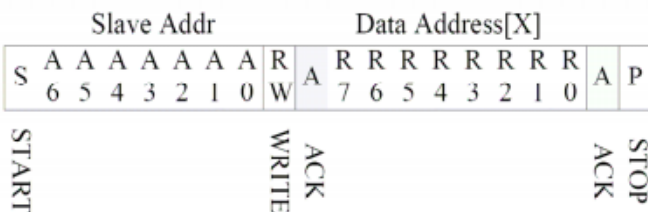
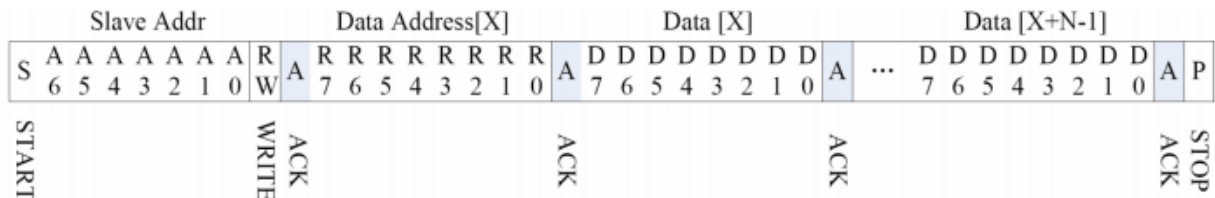

READ X BYTES FROM I2C SLAVE

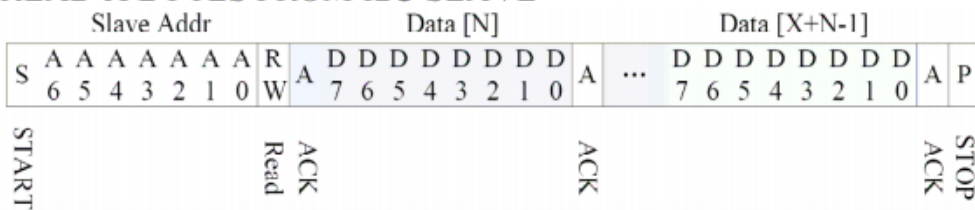

AS FOR STANDARD CTPM, HOST NEED TO USE BOTH INTERRUPT CONTROL SIGNAL AND SERIAL DATA INTERFACE TO GET THE TOUCH DATA, HERE IS THE TIMING TO GET TOUCH DATA.

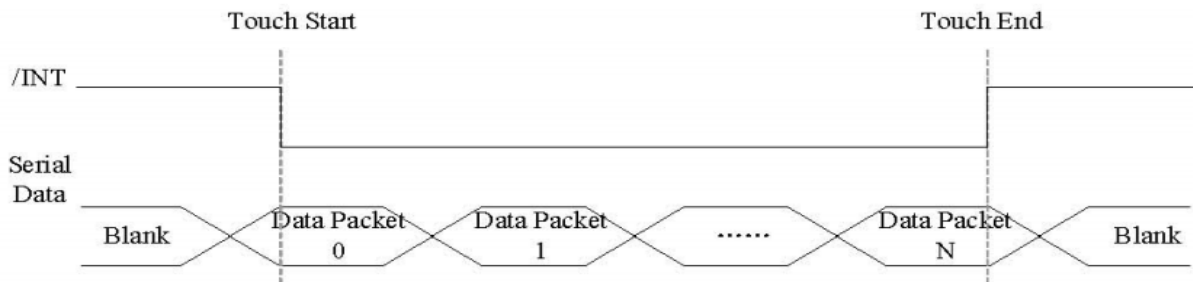

TOUCH DATA READ PROTOCOL

NAME	VALUE	DESCRIPTION
START CH	0X00	START COMMAND FOR CTPM TOUCH DATA PACKET,HOST MUST SEND CTPM A START CH COMMAND BEFORE READ TOUCH DATA
1st READ BYTE ~ LAST READ BYTE		TOUCH DATA PACKET SENT BY CTPM,EACH BYTE HAS 8-BIT DATA ,A TOUCH DATA PACKET CONSISTS OF N BYTE

A DATA PACKET STARTS WITH A HEADER AND ENDS WITH CRC CODE,AS FOR 5 POINTS DATA PACKET,THE LENGTH OF THE PACKET IS ALWAYS 26 BYTES IN SPITE OF ACTUAL TOUCH POINTS.

Address	Name	Bit7	Bit6	Bit5	Bit4	Bit3	Bit2	Bit1	Bit0	Host Access
00h	Devide__Mode		Device Model[2:0]							RW
01h	Gest__ID	Gesture ID[7:0]								R
02h	TD__Status					Number of touch points[3:0]			R	
03h	Touch1__XH	1 st Event Flag		1 st Touch X Position[11:8]					R	
04h	Touch1__XL	1 st Touch X Position[7:0]								R
05h	Touch1__YH	1 st Touch ID[3:0]			1 st Touch Y Position[11:8]					R

06h	Touch1__YL	1 st Touch Y Position[7:0]		R
09h	Touch2__XH	2 nd Event Flag	2 nd Touch X Position[11:8]	R
0Ah	Touch2__XL	2 nd Touch X Position[7:0]		R
0Bh	Touch2__YH	2nd Touch ID[3:0]	2ndTouch Y Position[11:8]	R
0Ch	Touch2__YL	2nd Touch Y Position[7:0]		R

0Fh	Touch3__XH	3rdEvent Flag	3rdTouch X Position[11:8]	R
10h	Touch3__XL	3rd Touch X Position[7:0]		R
11h	Touch3__YH	3rdTouch ID[3:0]	3rdTouch Y Position[11:8]	R
12h	Touch3__YL	3rd Touch Y Position[7:0]		R
15h	Touch4__XH	4thEvent Flag	4thTouch X Position[11:8]	R
16h	Touch4__XL	4th Touch X Position[7:0]		R
17h	Touch4__YH	4thTouch ID[3:0]	4thTouch Y Position[11:8]	R
18h	Touch4__YL	4th Touch Y Position[7:0]		R
1Bh	Touch5__XH	5thEvent Flag	5thTouch X Position[11:8]	R
1Ch	Touch5__XL	5th Touch X Position[7:0]		R
1Dh	Touch5__YH	5thTouch ID[3:0]	5thTouch Y Position[11:8]	R
1Eh	Touch5__YL	5th Touch Y Position[7:0]		R

12. Contour Drawing

